

Introduction to Physics I

Ideal gas law

change of state, adiabatic changes, gas pressure

Kinetic gas theory

- equipartition, degrees of freedom
- mean free path
- Maxwell-Boltzmann distribution
- Brownian motion

Ideal gas examples: adiabatic processes, heat capacity

Real gas law: van der Waals equation

Introduction to Physics I

For Biologists, Geoscientists, & Pharmaceutical Scientists

equipartition theorem



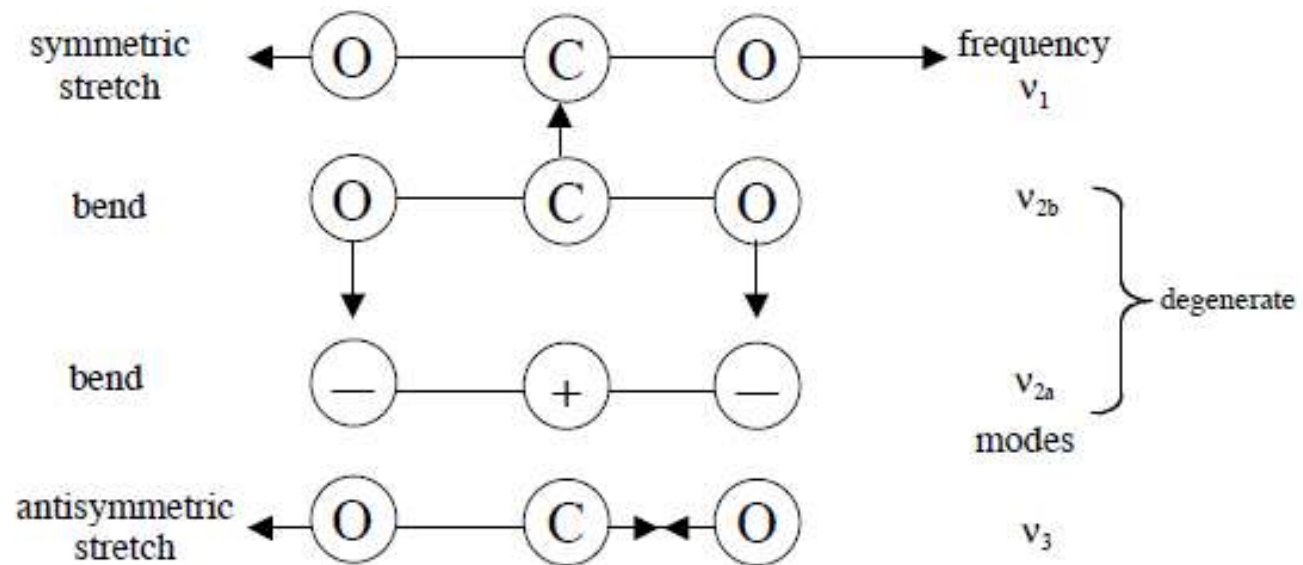

degrees of freedom

vibration modes CO₂ molecule



equipartition theorem

degrees of freedom

Gas	$i = \frac{\text{Atome}}{\text{Molekül}}$	f_{trans}	f_{rot}	f_{vibr}	$f_{\text{tot}} (=3i)$
He 	1	3	0	0	3
H ₂ 	2	3	2	1	6
CO ₂ 	3	3	2	4	9
NH ₃ 	4	3	3	6	12

NB: vibration modes contribute kinetic and potential energy to the total internal energy of the gas

mean free path collisions for a moving molecule

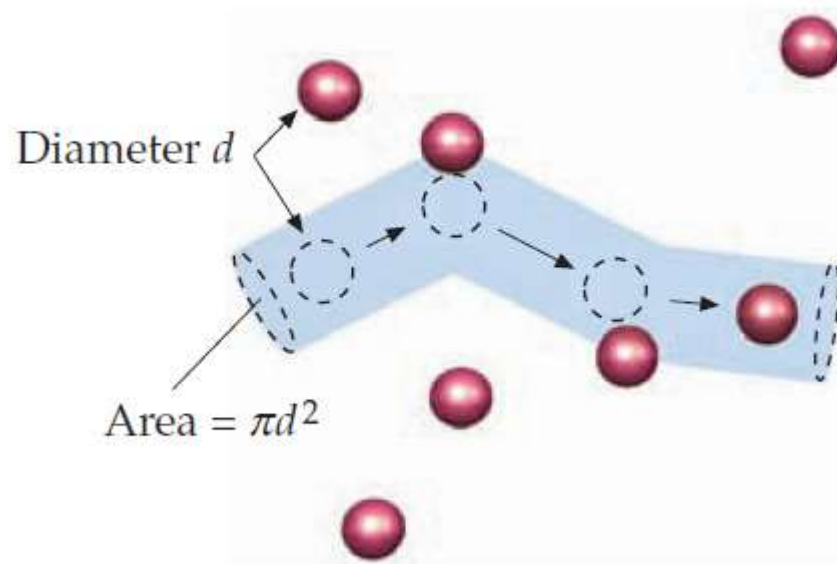

mean free path, ideal gas at STP

STP

standard pressure
& temperature

$P = 100\text{kPa}$ (1bar)

$T = 273.15\text{ K}$ (0C)

Atomic diameter

assumed here

0.3nm

The mean free path is 310 times the nominal atomic diameter and 28 times the average molecular separation.

Perspective of mean free path compared to average molecular separation. (Individual molecules are exaggerated in size by a factor of about 5)

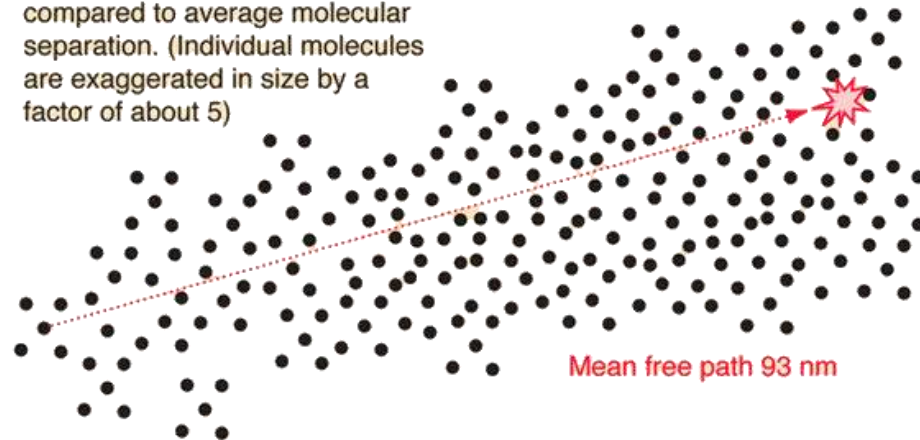

Average molecular separation
3.3 nm

Nominal atomic diameter
0.3 nm

Perspective of molecular size compared to average molecular separation.

The average molecular separation is about 10x the atomic diameter.

measuring the speed distribution of molecules

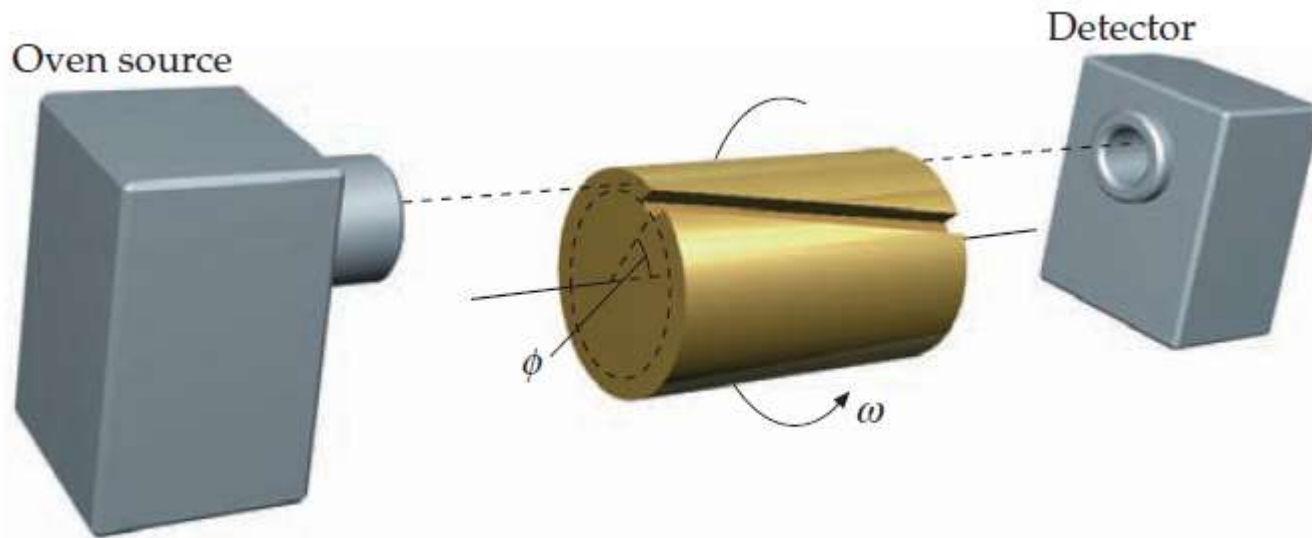

FIGURE 17-16 Schematic diagram of the apparatus for determining the speed distribution of the molecules of a gas. A substance is vaporized in an oven and the vapor molecules are allowed to escape through a hole in the oven wall into a vacuum chamber. The molecules are collimated into a narrow beam by a series of slits (not shown). The beam is aimed at a detector that counts the number of molecules that are incident on it in a given period of time. A rotating cylinder stops most of the beam. Small slits in the cylinder (only one of which is depicted here) allow the passage of molecules that have a narrow range of speeds that is determined by the angular speed of the rotating cylinder. Counting the number of molecules that reach the detector for each of a large number of angular speeds, gives a measure of the number of molecules in each range of speeds.

Maxwell-Boltzmann distribution

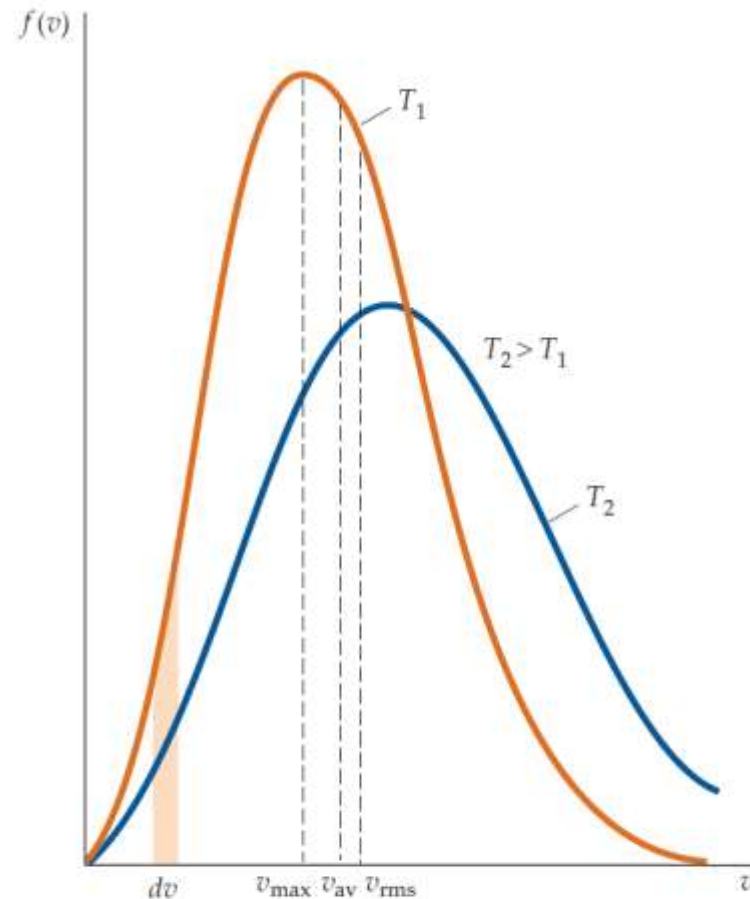





FIGURE 17-17 Distributions of molecular speeds in a gas at two temperatures, T_1 and $T_2 > T_1$. The shaded area $f(v) dv$ equals the fraction of the number of molecules having a particular speed in a narrow range of speeds dv . The mean speed v_{av} and the rms speed v_{rms} are both slightly greater than the most probable speed v_{\max} .

equipartition theorem

degrees of freedom & molar heat capacity

Molekül	Beispiel	$C_V(\text{J/mol}\cdot\text{K})$
eiatomig 	ideal	$3 R/2 = 12.5$
	He	12.5
	Ar	12.6
zweiatomig 	ideal	$7 R/2 = 29.0$
	N ₂	20.7
	O ₂	20.8
dreiatomig (gestreckt) 	ideal	$13 R/2 = 54.0$
	CO ₂	29.7

equipartition theorem

degrees of freedom

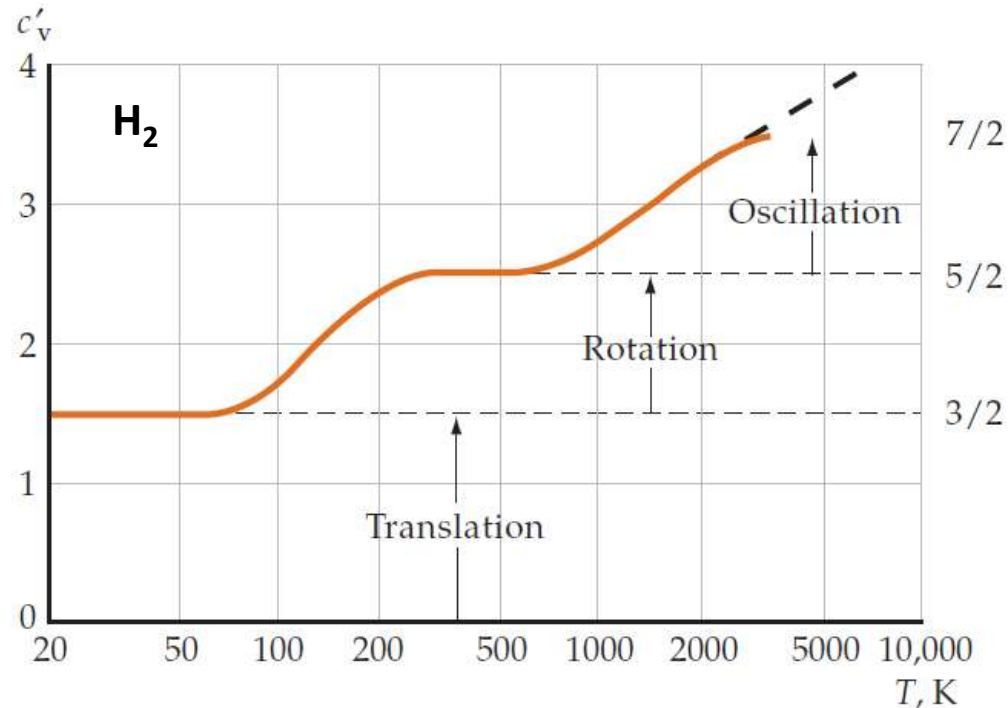

FIGURE 18-17 Temperature dependence of the molar heat capacity of H_2 . (The curve is qualitative in those regions where c'_v is changing.) Ninety-five percent of H_2 molecules are dissociated into atomic hydrogen at 5000 K.

equipartition theorem

heat capacity of a solid

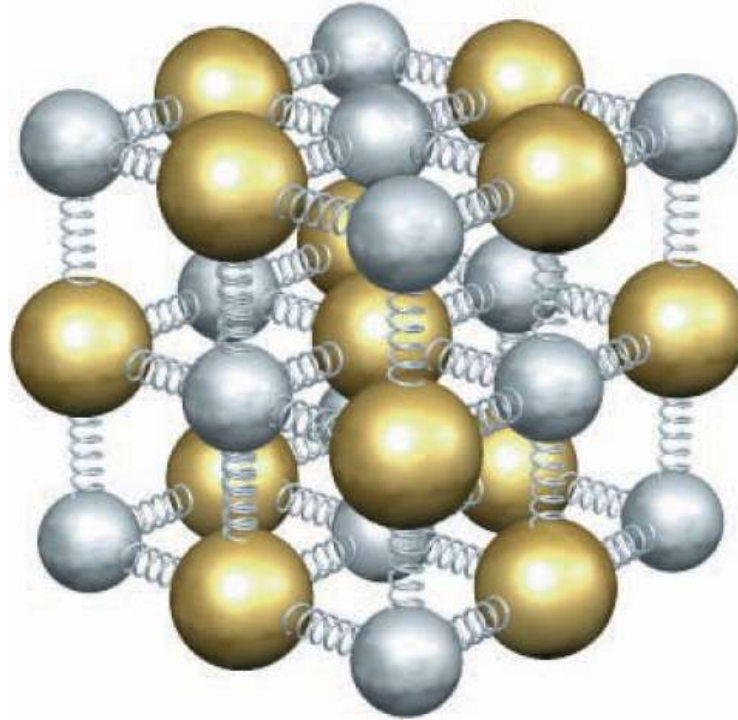

FIGURE 18-16 Model of a solid in which the atoms are connected to each other by springs. The internal energy of the molecule consists of the kinetic and potential energies of vibration.

adiabatic process

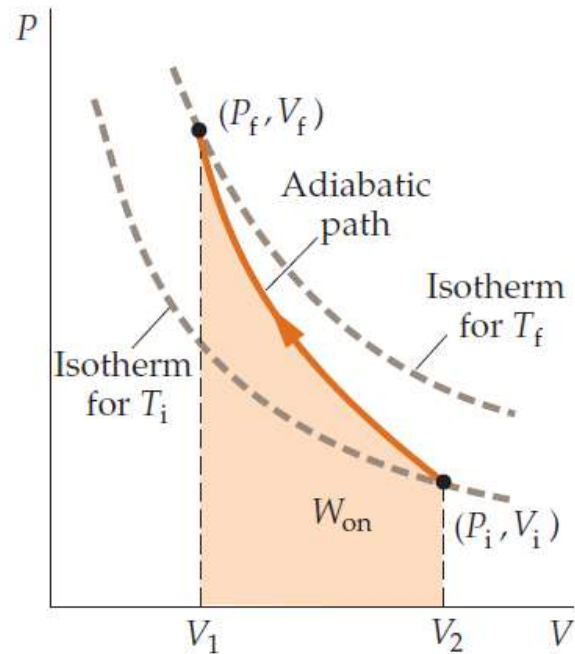

FIGURE 18-20 Quasi-static adiabatic compression of an ideal gas. The dashed lines are the isotherms for the initial and final temperatures. The curve connecting the initial and final states of the adiabatic compression is steeper than the isotherms because the temperature increases during the compression.

(Makro-)Mechanik



Temperaturschwankungen:

$$x_{\text{th}} = 0.2 \text{ pm} = 2 \times 10^{-13} \text{ m}$$

$$T = 21 \text{ }^{\circ}\text{C}$$

Nanomechanik



Temperaturschwankungen:

$$x_{\text{th}} = 8 \text{ nm} = 8 \times 10^{-9} \text{ m}$$

$$T = 21 \text{ }^{\circ}\text{C}$$

real gas law: van der Waals

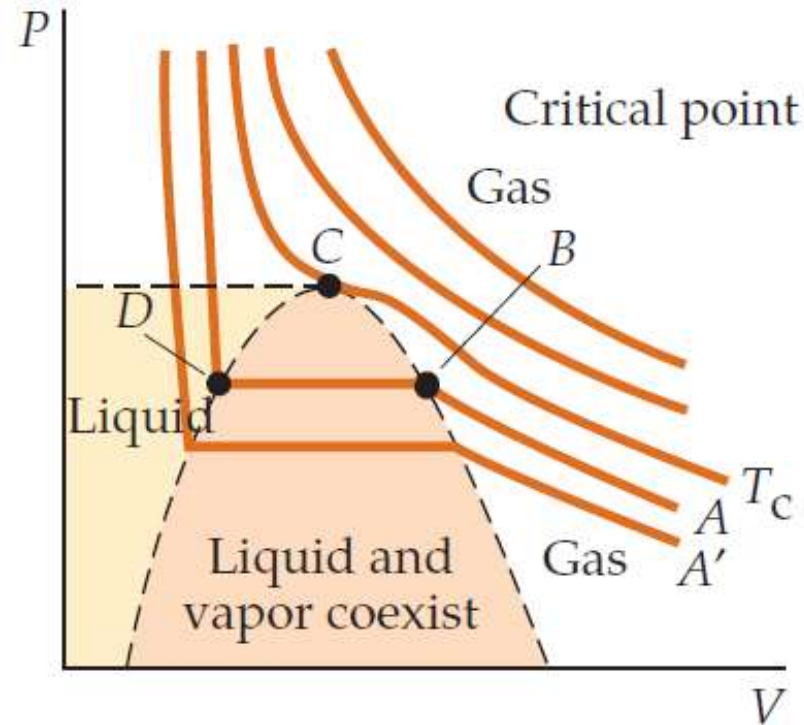
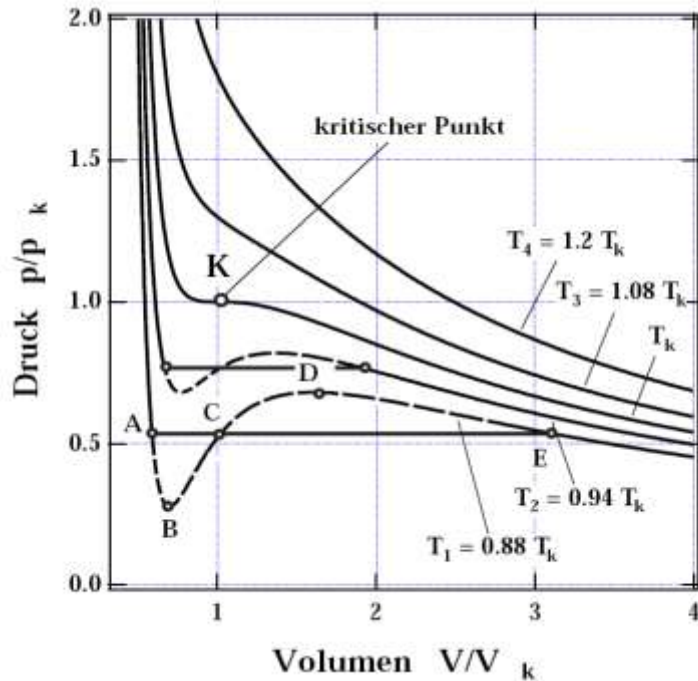
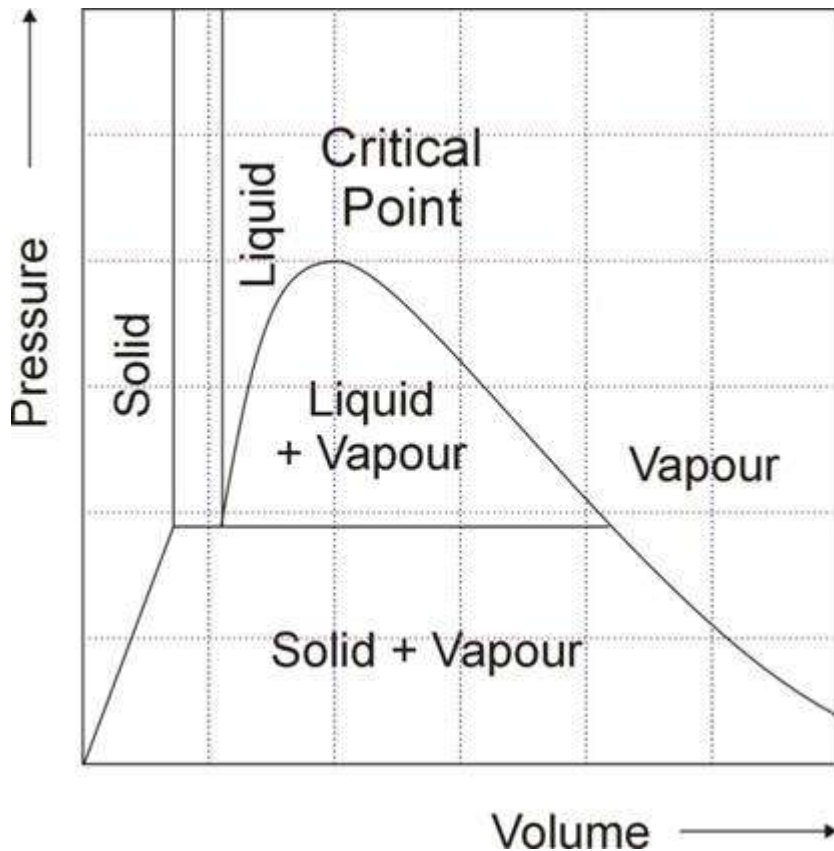

FIGURE 20-5 Isotherms on the PV diagram for a substance. For temperatures above the critical temperature T_c , the substance remains a gas at all pressures. Except for the region where the liquid and vapor coexist, these curves are described quite well by the van der Waals equation. The pressure for the horizontal portions of the curves in the shaded region is the vapor pressure which is the pressure at which the vapor and liquid are in equilibrium. In the region shaded yellow, to the left of the region shaded pink, the substance is a liquid and is nearly incompressible.

real gas law: van der Waals

PV diagram



PT diagram

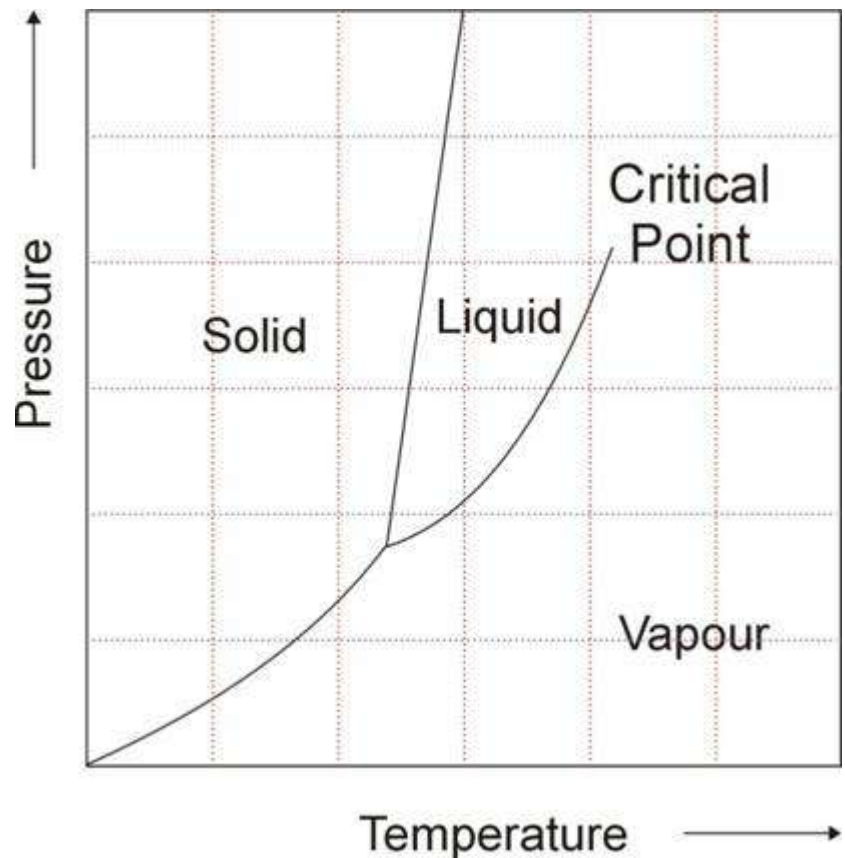

real gas law: van der Waals

PVT phase diagram

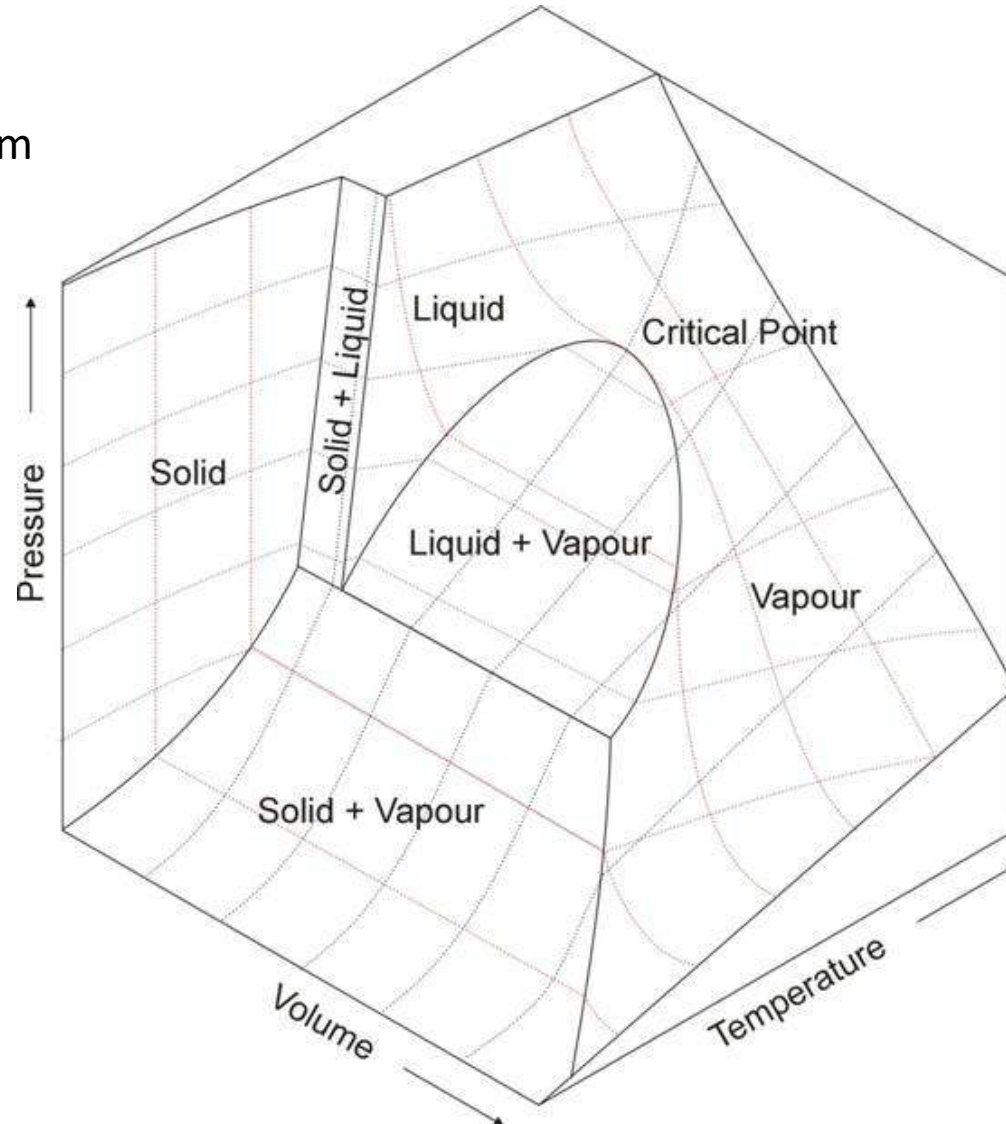

real gas law: van der Waals



Cloud forming behind an aircraft as it breaks the sound barrier. As the aircraft moves through the air, an area of low pressure forms behind it. When the pressure of this air parcel falls below the vapor pressure of gaseous water, the water in the air condenses to form the cloud. Different atmospheric conditions cause the phenomenon to occur at different aircraft speeds. (*U.S. Department of Defense/Photo Researchers, Inc.*)